



# IJRASET

International Journal For Research in  
Applied Science and Engineering Technology



---

# INTERNATIONAL JOURNAL FOR RESEARCH

IN APPLIED SCIENCE & ENGINEERING TECHNOLOGY

---

**Volume:** 10    **Issue:** V    **Month of publication:** May 2022

**DOI:** <https://doi.org/10.22214/ijraset.2022.43335>

[www.ijraset.com](http://www.ijraset.com)

Call:  08813907089

E-mail ID: [ijraset@gmail.com](mailto:ijraset@gmail.com)

# Carbon Emission and Battery Monitoring System

Deeksha D Shenoy<sup>1</sup>, K V Bhoomika<sup>2</sup>, Karishma Shetty<sup>3</sup>, Keerthana R<sup>4</sup> Dr. Laxmi Gulapagol<sup>4</sup>

<sup>1, 2, 3</sup>UG Student, A J Institute of Engineering and Technology

<sup>4</sup>Assoc. Professor, A J Institute of Engineering and Technology

**Abstract:** *Automobile exhaust gases are one of the most significant sources of carbon dioxide. Carbon monoxide from the exhaust system can seep into the vehicle through holes. Carbon dioxide poisoning can be lethal if inhaled at a specific dosage and for a long time. To ensure that the level of carbon dioxide in the vehicle is safe, the air quality must be monitored. Our goal is to create a project that focuses on vehicle carbon monoxide monitoring, alerting, and control. The carbon monoxide level in the vehicle is detected by the system. The collected sensor data will be stored in a database. The technology allows the user to keep track of carbon dioxide levels and vehicle battery discharge. The user can also be notified when carbon dioxide levels are dangerously high. When the battery level drops due to infrequent use of the vehicle, the system can provide effective notification about the battery discharge levels. The device is affordable and simple to install in the vehicle.*

**Keywords:** *Monitoring, Emission, Carbon, Battery, IOT, EV, Hybrid vehicle*

## I. INTRODUCTION

One of the most fundamental issues coming from technological advancement in all fields of business is the need to reduce the negative influence on the environment. Because of the dynamic exhaust emission levels, transportation is one of the most dynamically changing industries of economy. Measurements of exhaust emissions from combustion engines of machinery and vehicles, particularly under actual functioning conditions, are becoming increasingly important.

Pollution has quite dangerous health consequences. Poor air quality raises the risk of metastatic illnesses like respiratory illness and disease, as well as the risk of critical conditions like cancer, which burdens our health-care system with high medical costs. Particulate matter is responsible for up to 30,000 premature deaths every year. Passenger vehicles are the primary source of pollution, emitting significant volumes of nitrogen oxides, carbon monoxide, greenhouse gas, and other pollutants.

Carbon monoxide (CO) is a colourless, noxious, and odourless gas produced by incomplete combustion. The most common sources of this toxin are automobiles, heaters, and appliances that run on carbon-based fuels. Carbon monoxide (CO) gas is produced when carbon fuels are not completely burnt. The majority of CO emissions come from mobile sources. On-road vehicles (cars, trucks, motorcycles) and off-road vehicles and engines are among these sources (e.g., farm instrumentality, construction instrumentality, aircraft, marine vessels). As a result, high CO concentrations are most common in locations with heavy traffic.

In cities, car exhaust might account for up to 95 percent of total CO emissions (U.S. EPA, 2008). Industrial activities, non-transportation fuel combustion, and natural sources such as forest wildfires are all sources of CO emissions. CO Concentrations highlights the health risks associated with eupnoeic CO.

CO emissions from previously inventoried phylogenesis supply types are shown in this indicator: (1) "Fuel combustion," which includes emissions from coal, gas, and fueled power plants as well as industrial, commercial, and institutional sources, as well as residential heaters (e.g., wood-burning stoves) and boilers; (2) "Other industrial processes," which includes chemical production, fossil oil processing, metals production, and industrial processes other than fuel combustion; (3) "On-road vehicles," which includes cars, trucks, buses, and motorcycles; and (4) "Other industrial processes."

The National Emissions Inventory keeps track of CO emissions data (NEI). The NEI is a compilation of data from a variety of sources, with CO data mostly coming from Environmental Protection Agency models as well as state, tribal, and native air quality control agencies. Different information sources utilise various information collection methods, and much of the emissions data are based on estimations rather than real measurements. CO is a poisonous gas created when gasoline or fuel area units are burned. It's one of many compounds found in engine exhaust as a result of incomplete combustion. CO is a colourless, odourless, and tasteless gas that will quickly overwhelm anyone who is exposed to it. Headache, dizziness, sleepiness, or nausea may be the first signs of CO poisoning. Emesis, loss of consciousness, and collapse are all possible symptoms. If prolonged or high exposures area unit encountered. If the exposure level is high, loss of consciousness will occur while not alternative symptoms. Coma or death will occur if high exposures continue. The symptoms varies wide from individual to individual, and will occur sooner in highly prone people, like young or aged folks, folks with presistent respiratory diseases or cardiovascular disease, or those living at high altitudes.

A Ferret Instruments (Cheboygan, MI) Gaslink LT Five Gas Emissions Analyser and a KAL Equipment (Cleveland, OH) Model 5000 Four Gas Emissions Analyser were used to characterise the emissions from the generator and drive engines. CO, CO<sub>2</sub>, hydrocarbons, and oxygen are all measured by both analysers. The nitrogen oxides are also measured by the five gas analyser (NO<sub>x</sub>). Except for hydrocarbons and NO<sub>x</sub>, which are measured in parts per million, all values are in percentages. (A contamination concentration of one percent is 10,000 parts per million.) ToxiUltra Atmospheric Monitors (Biometrics, Inc.) equipped with CO sensors were used to detect CO concentrations at various locations on the houseboat. The ToxiUltra CO monitors were calibrated before and after usage, as directed by the manufacturer. These monitors are data logging gadgets with direct reading capability. The instruments were set to passive diffusion mode with a sample interval of 15B30 seconds. The instruments have a nominal range of 0 to 999 parts per million.

Because of their zero emissions and high energy potency, battery electric vehicles (EVs) (BEVs) are highly anticipated in China for lowering environmental emissions in the transportation sector. This chapter first examines the issue of EV ownership and use in China, then examines the angle and get intention to BEVs by examining the effects of various BEV ownership stimulation policies in China (such as license-plate lottery and BEV subsidies). Given the limited cruising range of BEVs, this chapter explores BEV drivers' usage behaviour by constructing a BEV drivers' charging and route alternative behaviour model based on expressed preference knowledge for key influencing parameters.

Finally, a charging alternative model is designed and calculable to accommodate charging demand estimation and charger locations. In Peiping, all empirical studies are carried out. Biomarkers (exposure, effect, and susceptibility) and techniques on exposure measuring ways, monitoring system, and analysis on new management systems, technologies, and merchandise square measure all extensively discussed behavioural and policy consequences of estimating outcomes. Transportation emits over half of the carbon monoxide gas and nitrogen oxides, as well as nearly a quarter of the hydrocarbons in our atmosphere. Automobile emissions are one of the most significant sources of carbon. A large concentration of carbon can be produced by an interior combustion hydrocarbon engine. The solution is to deploy clean vehicle and fuel technologies that aid in the reduction of transportation-related pollution and climate change emissions. The increasing number of vehicles on the road around the world, as well as the resulting contamination of the natural environment, leads to an increase of emission-related requirements. The current degree of technological improvement in all aspects of industry, including transportation, results in an increase in the demand for emission measurement systems.

A concentration of business became necessary in this matter in order to fulfil these requirements in accordance with dynamic regulations. Given the importance of reducing pollution caused by car exhaust, we intend to establish a project that will allow us to keep track of the proportion of pollutants emitted and reduce it, so lowering pollution.

#### A. Carbon Emission

Carbon dioxide emissions, also known as CO<sub>2</sub>, are emissions that result from the combustion of fossil fuels and the production of cement; they include carbon dioxide produced by the consumption of solid, liquid, and gas fuels, as well as gas flaring. Because carbon dioxide is a "greenhouse gas," it is an issue. CO<sub>2</sub> absorbs and emits infrared radiation due to its molecular structure, warming the Earth's surface and lower atmosphere.

#### Types And Amounts Of Vehicular Emissions

- 1) *Carbon Dioxide*: The primary environmental concern here is related to carbon dioxide's possible climatic impact. CO<sub>2</sub> is emitted by the combustion of fossil fuels. Estimates suggest that about 15% of the world's total man-made emissions of CO<sub>2</sub> are generated by motor vehicles and in some OECD countries the figure may reach 70%. Since CO<sub>2</sub> is a natural constituent of air (although only about 0.03%) it is not strictly viewed as a pollutant. Excess amounts of the gas have no direct detrimental effect on human health. The problem is that there is mounting, although some would argue not yet conclusive, evidence that high levels of CO<sub>2</sub> in the atmosphere, by preventing heat from escaping from the planet, will lead to global climate change.
- 2) *Carbon Monoxide*: CO is a colorless, odorless, and highly toxic gas, with a density close to that of air. It can have detrimental effects on health because it interferes with the absorption of oxygen by red blood cells. This may lead to increased morbidity and adversely affected fertility, and there is evidence that it affects worker productivity. CO is especially a problem in urban areas where synergistic effects with other pollutants means it contributes to photochemical smog and surface ozone formation.. Carbon monoxide results from the incomplete combustion of fuel and is emitted directly from vehicle tailpipes. Incomplete combustion is most likely to occur at low air-to-fuel ratios in the engine. These conditions are common during vehicle starting when air supply is restricted ("choked"), when cars are not tuned properly, and at altitudes where "thin" air effectively reduces the amount of oxygen available for combustion (except in cars that are designed or adjusted to compensate for altitude).

- 3) *Sulfur dioxide (SO<sub>2</sub>)*: SO<sub>2</sub> is a colorless, but strong smelling gas. It is the main sulfur compound emitted into the atmosphere. All combustion processes of products containing sulfur yield SO<sub>2</sub> emissions; hence, fossil fuels are mainly blamed for atmospheric SO<sub>2</sub>. Emissions of this gas can result in bronchitis and other diseases of the respiratory system, and it is the major contributor to ‘acid rain’. More importantly, coal-fired electricity generation is a major source of this gas, and there are further indirect environmental implications related to both the use of electronic rail transport and the manufacture of transport vehicles. The transportation share of sulfur-containing pollutants is primarily from engines running on diesel or home-heating oil containing 0.3% S (the upper limit of French specifications).
- 4) *Nitrogen Oxides (NO<sub>x</sub>)*: Acid rain is a term that is frequently linked with places where factories are located. However, when nitrogen and oxygen from automobile emissions combine, they form a group of hazardous chemicals known as nitrogen oxides. When nitrogen oxides are released into the atmosphere, they provide the conditions for hazardous acid rain to form. [1]

### B. Carbon Emission Measuring Unit

The details for carbon emission models relating to energy consumption can be found below. Based on the calorific equation, the type of carbon dioxide emissions specified by the IPCC [30], and the calculating method, the following is the calculation strategy for carbon impact of energy consumption:  $E_e = M \cdot Q \cdot EF(1)$  where  $E_e$  denotes the energy carbon emission component (mg/MJ),  $M$  is the energy consumption of solids and fluids (kg) or gas (m<sup>3</sup>),  $Q$  denotes the energy calorific value (MJ/kg), and  $EF$  denotes the energy carbon emission factor (mg/MJ). Because Equation (1) can only calculate carbon dioxide emissions, the CH<sub>4</sub> and N<sub>2</sub>O quantities must be transformed to CO<sub>2</sub>-equivalent values and then multiplied by the GWP. Aside from that, multiple global carbon computation models for each asphalt pavement construction process are necessary due to the diverse energy types and characteristics involved in each building process. Calculation models for various processes and greenhouse gases based on proposed qualitative standards and energy fuel attributes are included. [2]

① Calculation model for the carbon emission of diesel:

$$E_{ei} = V_i \cdot \rho_i \cdot \eta_i \cdot Q_i \sum_{j=1}^3 GWP_j \cdot EF_j$$

② Calculation model for the carbon emission of coal or heavy oil:

$$E_{ei} = m_i \cdot \eta_i \cdot Q_i \sum_{j=1}^3 GWP_j \cdot EF_j$$

③ Calculation model for the total carbon emission from energy consumption:

$$E_e = \sum_{i=1}^8 E_{ei} (i \neq 5)$$

An automotive battery, often known as a car battery, is a rechargeable battery that is used to start a vehicle. Its primary function is to supply an electric current to the electric-powered starting motor, which then starts the chemically-fueled internal combustion engine that drives the vehicle. The battery continues to supply power to the car's electrical systems once the engine is running, with the alternator charging the battery as demand increases or decrease.

### C. Types of Batteries

Electric vehicles powered by batteries are beginning to make an impact in the automobile business today. There are many different types of batteries used in today's electric vehicles, making it difficult to determine which one best meets all of the most important characteristics from various perspectives, such as energy storage efficiency, structural characteristics, cost price, safety, and utilisation life. The autonomy of an Electric Vehicle using four distinct types of batteries: Lithium Ion (Li-Ion), Molten Salt (Na-NiCl<sub>2</sub>), Nickel Metal Hydride (Ni-MH), and Lithium Sulphur (Li-S), all of which have the same electric energy storage capacity, is presented in this study. [3]

Electric Battery component general parameters

Name	Value for Battery Type				Unit
	Li-Ion	Na-NiCl <sub>2</sub>	Ni-MH	Li-S	
Maximum Charge	75	84	85	80	Ah
Nominal Voltage	323	289	288	305	V
Stored Energy	24.2	24.2	24.2	24.2	kWh
Maximum Voltage / Minimum Voltage	339 / 308	275 / 304	274 / 302	290 / 320	V
Initial Charge	100	100	100	100	%
Number of Cells per Cell-Row	12	12	20	26	-
Number of Cell-Row	17	30	20	1	-
Internal Resistance charge/discharge	1 / 1	1 / 1	1 / 1	1 / 1	Ω
Operating Temperature	33	270	36	30	°C
Specific Heat Transition	0.4	6	0.4	0.08	W/K
Specific Heat Capacity	795	950	677	1650	J/kg*K
Mass of Battery	318	457	534	173	kg
Battery Price	300	500	400	250	€

The volt is a derived unit that represents electric potential, electric potential difference (voltage), and electromotive force. It is named after Alessandro Volta (1745–1827), an Italian physicist.

The colder the temperature, the lower the battery voltage, and the more stress on the battery comes from the FW strategy's earlier operation. This results in a rapid drop in SOC and, as a result, low battery voltage supply. The inverter saturates at this point, preventing EV functioning. [4]

D. Hardware and Application

1) *PCB Design*: PCB design is critical for all types of power converters, particularly those used in industrial applications. The strain inductance linked with the circuit is one of the elements that influences PCB design and robustness. Precision is essential while designing control circuits. Reduced strain inductance, as well as simplicity, flexibility, compactness, and better cooling management, are necessary to make the PCB design reliable. These factors are essential for precise PCB design, performance, low power consumption, and high-power converters at high manufacturing speeds. This work also discusses how to eliminate signal delays by adjusting trace lengths [5].

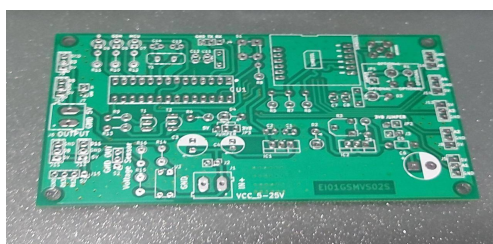

Fig 1: The PCB Board

2) *MQ7 Sensor*: The Internet of Things (IoT) is now widely used in almost every industry, and it also plays an important part in our air quality monitoring system. Our arrangement will display the air quality in PPM (Parts per Million) on a web page, allowing us to conveniently monitor it. The pollutant level can be monitored using a PC or a mobile device in this IoT project [7]. The MQ7 sensor has a high sensitivity to carbon monoxide and can detect its concentration in the environment.

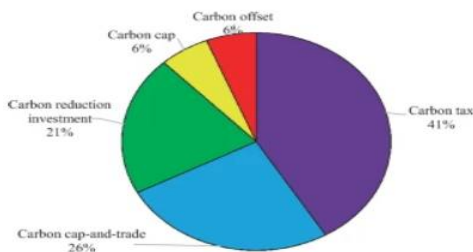

Fig 2: Carbon Emission percentage systematic analysis [8]

CO emissions from petrol fuel generators have relatively lower values that are somewhat constant, i.e. virtually steady, as shown in the graph. Carbon monoxide emissions from diesel fuel generators can be high due to age, being in a confined space, or the fact that diesel fuels have a far higher carbon content than gasoline fuels[8].



Fig 3: Carbon Monoxide Sensor [9]

A carbon monoxide detector, often known as a CO detector, is a device that detects the presence of carbon monoxide (CO) gas in order to prevent CO poisoning. CO detectors are meant to track CO levels over time and sound an alarm before dangerous levels of CO build up in a space, providing individuals enough time to ventilate or leave safely. [9]

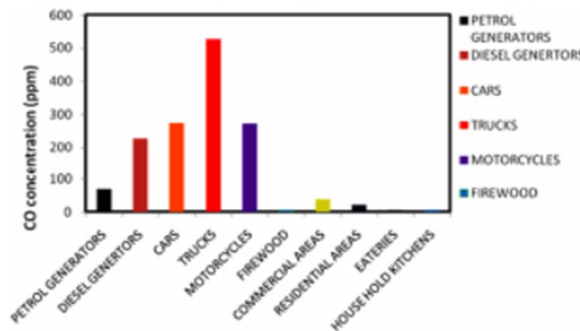

Fig 4: The average values of CO emissions from different sources and environment [9]

Figure 4 shows the average values of carbon monoxide emissions from several sources in the research area. Carbon monoxide emissions from environmental sources (such as commercial areas, residential areas, eateries, household kitchens, and firewood cooking spots) are relatively small in comparison to values recorded in machines that run on fossil fuels (i.e. petrol generators, diesel generators, cars, motorcycles, and trucks), as shown in this graph. It's possible that the cause is related to the engine and fuel utilised (diesel). The graph also revealed that generators using diesel fuel emit more carbon monoxide than the generators using gasoline.

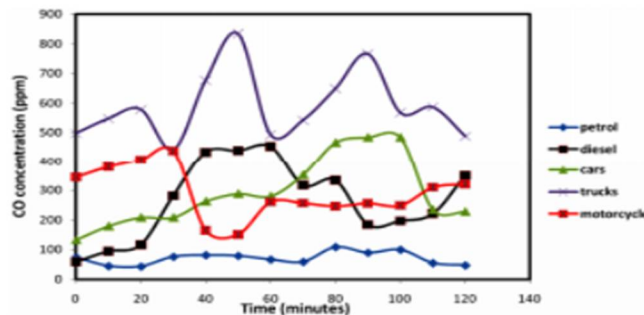

Fig 5: Average values of CO emissions from various sources [9]

Figure 5 depicts graphical representations of average CO emission values from several sources. The graph includes data from gasoline and diesel generators, as well as vehicles, motorcycles, and trucks. CO emissions measured ranged from roughly 45 parts per million to about 835 parts per million. In general, the values reported during field work changed on a regular basis. The differences in values found in cars, motorbikes, and trucks were attributed to the volume of vehicles on the road at the time and the vehicles' age. [9]

*E. Android Studio is used to create Android applications.*

Android is an open source architecture that contains the operating system, application framework, Linux kernel, middleware, and apps, as well as a set of API libraries for creating mobile applications that can give mobile handsets the look, feel, and functionality. Without any difficulty or complexity, the Android mobile operating system also provides a versatile environment for developing Android mobile applications, as developers can utilise both Java IDEs and Android Java Libraries. [10]

**II. ANDROID ARCHITECTURE**

We studied the Android working device structure. Android device is a Linux-primarily based totally device, Android working device is a stack of software program additives that is more or less divided into 5 sections and 4 fundamental layers as proven beneath within side the structure diagram. [11]

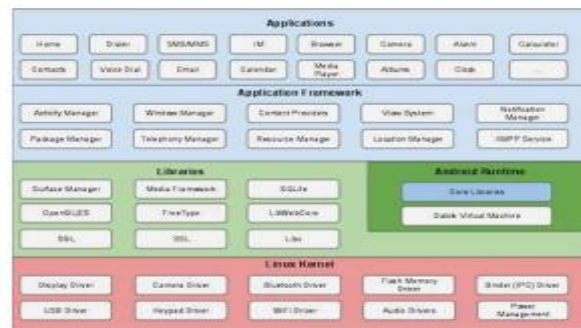

Fig 6: Android architecture [11]

**III. THE DEVELOPMENT PROCESS**

An Android software work begins with an idea and the requirements necessary to implement it. Interpreting statutes and needs: Most applications start with such a idea of what they should do, which is then refined through market and user research. At this point, the app's requirements are specified. Designing and Developing the App: An app is created up of one or more activities. For each activity, use Android Studio to complete the steps below in the order listed. Create the Java code such follows: Use testing and debug tools to create Java source for modules and tests. Create custom build for various versions of your application or reuse the default build structure. Put the application out there: Assemble the final App (application package file) and release it via Play Store. [12]

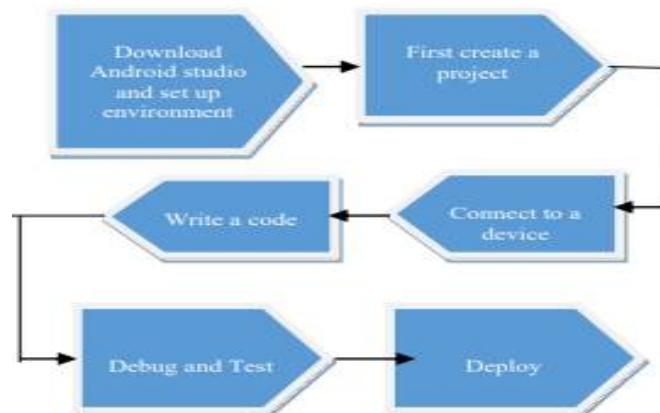

Fig 7: Process of developing Android Application

#### IV. ANDROID ACTIVITY LIFE CYCLE

The App for android Activity class has seven methods that control the activity lifecycle.

- 1) **OnCreate:** When an activity is first formed, this method is called.
- 2) **OnStart:** Performed when the user's activity becomes apparent.
- 3) **OnResume:** Run when the activity begins communicating with the user again.
- 4) **OnPause:** Named when the user cannot see any activity.
- 5) **OnStop:** Fired when the user no longer sees any activity.
- 6) **OnRestart:** Actually named after your activity has been halted and before it begins again.
- 7) **OnDestroy:** This method is called before the activity is destroyed. [14]

#### V. LITERATURE WORK

An embedded tool is designed and tested for toxic fueloline detection indoors a automobile cabin the use of ATMEL 89C51 microcontroller. Toxic fueloline like CO is plenty much less sensible thru manner of approach of human which endangers the human lives. This important scenario can be averted thru manner of approach of enforcing the sensors for sensing the quantity of CO and oxygen level and is displayed every second. When the CO level exceeds ordinary level that is CO is more than 30ppm and if the Oxygen level decreases below the ordinary level of 19ppm then the designed tool affords an alarm and moreover the warning message to the prison customer. [15]

A wireless allotted mobile air pollution monitoring device have become designed, achieved and tested the use of the GPRS public network. The device uses metropolis buses to build up pollutant gases which encompass CO, NO<sub>2</sub>, and SO<sub>2</sub>. The pollution information from severa cell sensor arrays is transmitted to a main severa that make this information available on the Internet thru a Google Maps interface. The information shows the pollutant stages and their conformance to neighbourhood air superb standards. It is truly properly really well worth mentioning that plenty more art work is wanted to commercialize the device. [16]

The exponential increase of IoT gadgets and their ordinary packages requires their class so one can cope with today's protection and privateness issues affecting the trustworthiness of the world's modern-day IoT domain. This class offers modern-day customers of IoT gadgets the cap potential to look and recognize the dangers and discover a powerful manner to implement protection and privateness controls of their IoT environments. IoT tool producers ought to take this class under consideration while designing and production IoT gadgets and its additives to make sure that protection and privateness is carried out through layout and does now no longer come up as an afterthought for the duration of the IoT tool improvement lifestyles. [17]

Thousands of people are dying because of inhaling Carbon monoxide (CO) gas each year, and in contrast to other poisons it has the highest accidental deaths – not only because of its deadly nature, but seeing, smelling or tasting it is impossible, and it doesn't annoy mucous membranes or skin. CO is fast-acting. It's often too late by the time victim notices symptoms of poisoning. Any carbon-based fuel (gas, coal, petroleum, etc.) incomplete combustion will result in producing Carbon monoxide. Every year many people are poisoned and died by inhaling CO gas. For those who own LPG cars or stuck in the car in the winter or warming up a vehicle in a garage the lack of CO alarm system especially inside the vehicle is a big mess. We proposed a system that is able to sense and make alarm and even send warning messages include vehicle coordinates to certain phone numbers. This system is not expensive and can be installed on every vehicle easily. [18]

Understanding the sorts of disasters which have happened, the sorts of exams which have been undertaken, and the technique of lifespan prediction can all assist to beautify EV battery reliability. The proposed methodologies can make sure that the reliability of electrical automobile battery structures or additives meets expectations, values, in addition to the capacity to increase battery life, wherein the battery choice relies primarily based totally at the necessities of the software Field data, usage, and environmental factors, on the alternative hand, profile are vital in in addition improving the EV battery's dependability. [19]

The quantity of papers within side the subject of out of doors air pollutants and breathing fitness is constantly growing. In different areas including the Middle East, Africa, and Southeast Asia, however, studies output and worldwide collaboration have been low. There is a want for a worldwide multidisciplinary studies community that consists of international locations with excessive ranges of air pollutants and constrained resources. Environmental pollutants studies can also cognizance on stopping pollutants issues with the aid of using spending greater in inexperienced technology. [20]. The paper is primarily based totally on a proof of such technologies, their function, the negative aspects of such technologies, the performance of hybrid automobiles, case research of cutting-edge industrial hybrid vehicles including the Toyota Prius series, Astrolab, and the fuels and uncooked substances utilized in hybrid vehicles. The paper finishes with a dialogue of the advantages and disadvantages of hybrid vehicles, in addition to how this era will in the end take over the arena and update gas and diesel vehicles. [21]

This studies assessed current records approximately the health, economic, and climatic results of stratosphere smog and black carbon dioxide emissions, in addition to mitigation options. Lower emissions are an extraordinarily climatically powerful mitigation choice which is likewise regular with industrialising countries' improvement techniques due to the fact a number of the affects are local, have a quick atmospheric lifetime, and there are cost-powerful abatement strategies which have already been broadly utilized in advanced countries. [22]

This studies examines current traits in greenhouse gas (GHG) emissions, which include each CO<sub>2</sub> and non-CO<sub>2</sub> GHG emissions, as much as 2018. These emissions had been calculated the use of the EDGAR database model 5.zero for CO<sub>2</sub> from fossil gasoline use and carbonate uses (together with cement clinker manufacturing and lime manufacturing) (Crippa et al., 2019)<sup>5</sup>, which became primarily based totally frequently on IEA electricity statistics (IEA, 2017a), in addition to the new edition 5.zero for methane (CH<sub>4</sub>) and nitrous oxide (N<sub>2</sub>O) launched this year (Crippa et al., 2019). [23]

Uses of publicly to be had facts had been analyzed and analyzed on this examine. Data reassets are indexed withinside the Data and Flexibility segment of this paper for details. All the authors indexed make a significant, direct, and able contribution to the paintings and authorize it for publication. This examine makes use of some of device gaining knowledge of algorithms, or function,  $f$ , to map output ( $Y$ ) from enter variables ( $X_1, X_2, \dots, X_6$ ) to  $Y = f(X_1, X_2, \dots, X_6)$ . Algorithms that simplify the challenge in a famous manner are referred to as trustworthy fashions. Examples of this magnificence consist of item rotation, line deflection etc. In this examine, we tested 3 linear fashions, and people of linear regression (LR), overall discount and operator selection (LASSO), and Elastic Net (EN) that upload regular fines to paintings losses for the duration of training. Line fashions offer benchmark benchmarking for different device gaining knowledge of algorithms. [24]

The following policy is presented in this paper. First and importantly, we must aggressively boost carbon emissions research. The results suggest that disregarding the impact of total investment and exports on carbon emission can lead to accounting inaccuracies. As a result, the above mentioned parameters should be analysed in order to increase the carbon emissions ratio's accuracy. Second, overall energy consumption mix must also be improved. In particular, we must significantly expand the share of low carbon consumption, such as natural gas, with the backing of policy and direction, in order to limit the share of high carbon consumption, such as green coals, in order to sustain the requirement for economic development. Third, we must boost manufacturing in order to conserve energy. [25]

This paper specializes in the studies techniques and steps worried in undertaking research on distinctive varieties of carbon steps. In addition, a comparative look at of the measurements of various carbon footprint exams become executed to become aware of similarities, variations and shortcomings. Policies, principles, studies parameters, calculation techniques, statistics choice and different factors of the organization's footprint and product carbon footprint had been analysed, respectively. [26]

The most important contribution to the domain has been reported from China, the United States and England. Although most of the authors and domain institutions are from China, authors and institutions in the United States have reported excellent links. It was revealed that the study of greenhouse gas emissions and the measurement of carbon footprint were popular among researchers. In addition, climate change and the natural effects of carbon emissions have also been key factors of concern in air pollution research. The key findings of this study will be of benefit to policymakers, academics, and institutions to determine future research guidelines and identify potential contacts to assist in developing air pollution control policies and future carbon reduction targets. [27]

Meeting the dreams of lowering international weather extrade would require that greenhouse fueloline emissions start to decline in the subsequent many years and keep to decline. A sort of automobile technology and gasoline are commercially to be had to clients these days that could lessen carbon emissions. But what are the first-class alternatives, and is there sufficient to satisfy the weather coverage objectives? Here, we study the price and sturdiness of a hundred twenty five mild automobile fashions within side the U.S. market. these days and we're trying out those fashions in opposition to U.S. pollutants discount targets. of 2030, 2040, and 2050 are consistent with the aim of lowering international warming. as much as 2 ° C above pre-commercial levels. Our outcomes display that clients do now no longer should pay more for a low-carbon automobile. With all of the unique set of automobile fashions and examined powertrain technology, a smooth automobile is generally the least high-priced automobile. Although the carbon depth ratio of vehicles bought in 2014 exceeds the 2030 weather stage through extra than 50%, we discover that maximum of the hybrid electric powered vehicles and batteries to be had these days meet those targets. By 2050, handiest electric powered cars which have been furnished with nearly general carbon energy are predicted to satisfy weather standards. [28]

As concern over climate change garners attention the question of whether it's passing gives way to what policymakers should do about it. The question of policy is a profitable bone. This exploration is necessary because climate change, left unbounded, threatens to permanently change our terrain. In Profitable terms, CO<sub>2</sub> emigrations would be described as an externality. The diligence that produce the contaminant don't pay for the damages they induce on the terrain.

Economists have meditated on similar externalities before. In a classic trial, Plott argued that policy measures to internalize these externalities were necessary. That is, programs that include the cost of pollution in the profitable opinions made by enterprises and consumers should be legislated. His logic, and experimental results, suggested that bare concern over the weal of others isn't sufficient to cover society from environmental damages (1983). Plott, still, didn't consider a farther complication of environmental economics. A politically seductive result to climate change is to support exploration and development (R&D) as an answer to climate change. The studies I consider then will consider this question in confluence with styles of internalizing climate change externalities. [29]

This take a look at goals to check the literature in lowering carbon emigration from pressure chain gadget for the as soon as oftentimes and supplying motorists, hedge, overall performance index, and practice. The difficulty of lowering carbon emigration come continuously bandied given that unplanned and reckless behaviour with the aid of using diligence are implicit pitfalls to sustainability. Companies are actually seeking to limit environmental affects with the aid of using integrating environmental establishments into their pressure chain operations. In the cease of lowering carbon emigrations, the assiduity is confronted with distinct motorists, walls, and overall performance index. With a whole lot of troubles confronted, the practices taken to lessen carbon emigrations are assuredly distinct. Thirty papers had been accrued from former research and related to dialogue points. The end result confirmed that properly collaboration with colourful media within side the pressure chain gadget could be appropriate to attain not unusual place pretensions in lowering fueloline emigrations. [30]

Air pollutants has come predominant trouble for each nation, whether or not it is advanced usa or growing usa. Health problem had been developing unexpectedly specifically in communal regions of growing international locations in which industrialization and developing wide variety of cars ends in launch of lot of air pollutants. Adverse items of pollutants can beget antipathetic responses analogous as vexation of the throat, eyes and nostril in addition to a few critical issues like bronchitis, coronary heart situations, pneumonia, lung and irritated asthma. According to a check, because of air pollutants to untimely deaths in step with time do within side the U.S. alone. Whereas in EU wide variety reaches to and over worldwide. Air Pollution Monitoring System video display units the Air great over an internet garçon the use of Internet and could spark an alarm while the air great is going down past a sure threshold position, approach while there may be enough quantity of poisonous feasts gift within side the air like CO<sub>2</sub>, bank, alcohol, benzene, NH<sub>3</sub>, LPG and NO<sub>x</sub>. It will display the air great in PPM (Corridor Per Million) at the Television and in addition to on net runner in order that it is able to cowl it in reality easily. It's important to oversee air great and maintain it below manipulate for an advanced destiny and wholesome dwelling for all. Due to tension and occasional fee Internet of items (IoT) is getting famous day through day. With the Industrialization and with the growth within side the cars on avenue the atmospheric situations have notably affected. Adverse items of pollutants encompass slight antipathetic responses analogous as vexation of the throat, eyes and nostril in addition to a few critical issues like bronchitis, coronary heart situations, pneumonia, lung and irritated asthma. Monitoring offers measures of air adulterant and sound pollutants attention, which also can be resolved interpreted and presented. This fact also can be relevant in multitudinous ways. [31]

This have a look at become accomplished to dissect the versions of risky adulterants like Carbon Monoxide (CO), Carbon Oxides (CO<sub>x</sub>) and Nitrogen Oxides (NO<sub>x</sub>) in Tamil Nadu. The principal supply of air pollutants in civic regions notably in growing nations like India is because of the transportation sector. Road and Transportation Office (RTO) and Central Pollution Control Board (CPCB) are the tracking government of the emigration norms. This paper measures the emigrations norms in a real- time procedure the use of colourful detectors videlicet bomb detector that's located on the exhaust of the automobile. The Indian authorities presents the Fitness Certificate (FC) for each automobile via way of means of overlaying its geste. The manage approach rendering for calculating the emitted fueloline limits has been finished in PIC Microcontroller which analyzes the statistics and yields the facts which might be additionally in comparison with the usual values. Motorists and close to manage stations are passed with nonstop remarks and warnings if the boundaries are exceeded. The Gas detector is hooked up withinside the proposed manage device via way of means of indicating the values passed withinside the Liquid Crystal Display (TV). [32]

The Internet of Things (IoT) is thought to be the subsequent step in evolution of the Internet. IoT is described as an international community of impacts, every that has its very own awesome identity, which can be related through an extensive variety of networks to regulate information and gift it as critical information. The Internet of Things (IoT) is a brand new era this is remodelling the ICT industry. The Internet of Effects also can be appeared of as a virtual shape of an personally identifiable clever object. Multiple related technologies, together with Wireless Sensor Network (WSN) and Radio Frequency Identification (RFID), are utilized by IoT devices at the net to cloverleaf information (RFID). In addition, combining IoT and Pall complements stop development. In particular, combining IoT with Pall promotes stop development. The authors have furnished the four-focused armature of IoT, offerings furnished through IoT, and modern IoT operations to gain the growing frame of studies on IoT. [33]

Other related papers on Carbon Emission and Battery Monitoring System

Serial No.	Reference	Title	Year	Technology
1	Pejman Panahi et al. [34]	Car indoor Gas detection system.	2017	One or two MQ7 gas sensor are installed inside the car. They are connected to main module.Arduino Mega is main board.
2	V.Ramyaa , Palaniappanb , K.Karthickb , Subash Prasad et al.[35]	Embedded System for Vehicle Cabin Toxic Gas Detection and Alerting	2018	The level of the toxic gas CO is continuously sensed by the sensor MQ-7. The level is displayed in the LCD continuously for every second. When the level of the toxic gas CO and Oxygen decreases than the normal level ,then microcontroller proceeds with an alarm
3	Tsvetan Tsokov and Dessislava Petrova-Antonova et al.[36]	IoT Platform for Control of Carbon Emission	2019	Uses an IoT Platform called EcoLogic. The EcoLogic consists of hardware module that collects sensor data related to vehicles' carbon emissions and cloud based applications for data processing.
4	Dr.M.Newlin Rajkumar Sruthi et al.[37]	IOT based Smart system for controlling CO2 emission	2020	emission of carbon is monitored using Raspberry pi embedded into a Cloud Server. The temperature sensor are used.
5	Yinjiao Xing , Eden W. M. Ma, Kwok L. Tsui et al. [38]	Battery Management System in Electric and Hybrid Vehicles	2019	The paper focuses on the latest methodologies for the state evaluation of batteries.
6	Madu Amajor, James Nguyen et al.[39]	Real Time Automotive Battery Monitoring System	2018	The purpose of the Real Time Automotive Battery Monitoring System is to prevent the discharge of a car battery beyond the point of restarting the car. Implementation is done using the circuit in PSpice, and the circuit on a bread board
7	Xingyu Tao, Chao Mao , Fangyun Xie, Guiwen Liu[40]	Greenhouse gas emission monitoring system for manufacturing prefabricated components	2018	Shows the real-time monitoring interface, which is divided into four areas, namely: componentlocation, calculation of results, data visualization, and real-time video
8	Mohd Helmy Abd Wahab, Nur Imanina Mohamad Anuar et al. [41]	IoT-Based Battery Monitoring System for Electric Vehicle	2018	This system is capable to detect degraded battery performance and send notification messages to the user for further action. Wireless technologies used are GSM, ZigBee, GPRS, Android, WIFI and Bluetooth communication
9	Ignatius Nakhoywa Barasa, Justus Simiyu , Sebastian Waita et al. [42]	Automobile Battery Monitoring System using Arduino Uno R3 Microcontroller Board	2017	Uses the voltage loss associated with each engine cranking event to compute the state of health of the car starter battery and has a voltage divider, current and temperature modules designed for measuring the battery's voltage, current and temperature respectively using a microcontroller on an Arduino Uno R3 computing board.
10	Gao Yanwei, Zhang Yujun, He Ying, You Ku, Chen Chen et al.[43]	On-board Exhaust Emission Measurements of Vehicles Using a Portable Emission Measure System	2016	In this, the PEMS equipment used for emission measure is SEMTECH ECOSTAR gas analyzer .It has a flame ionization detector (FID) for hydrocarbons measurements.
11	Zhenhi Xu, Yu Kang,Wenjun Lv et al.[44]	Analysis and Prediction of Vehicle Exhaust Emission Usingg ANN	2017	Multiple Linear regression model. Makes use of least squares estimation method. The Lasso algorithm used here can resolve all the shortcomings of least square emission.
12	Yingshuai Liu and Jianwei Tan et al.[45]	Green Traffic-Oriented Heavy-Duty Vehicle Emission Characteristics of China VI Based on Portable Emission Measurement Systems	2020	Pollutant Control Technology is used.The device here consists of a DOC, DPF, selective catalytic reduction (SCR) device and ammonia slip catalystr.

MC ATMEGA328/P

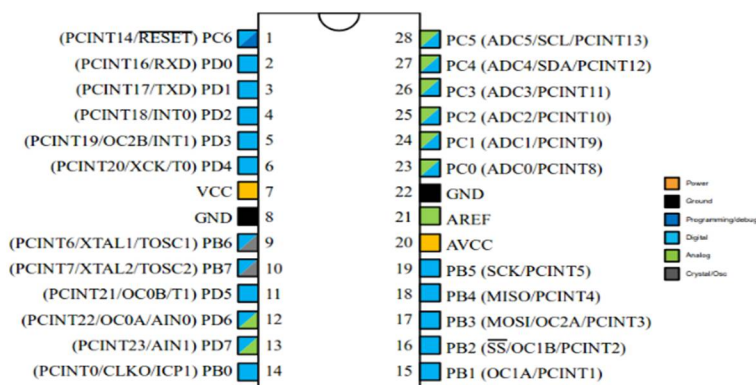

Fig 9: Atmega 328P [46]

Pin No.	Pin Name	Pin Function	Pin Function Description
1	PC6	Reset	This pin assists in embedded controller reset
2	PD0	Digital Pin (RX)	For serial communication, this is the input pin.
3	PD1	Digital Pin (TX)	This is the serial communication output pin.
4	PD2	Digital Pin	It's a kind of interrupt 0
5	PD3	Digital Pin	It was a form of external interrupt 1.
6	PD4	Digital Pin	It's used to power the system's external counter source, Timer 0.
7	Vcc	Positive Voltage	Supplying the power.
8	GND	Ground	Grounding
9	XTAL	Crystal Oscillator	To give an external clock pulse to the chip, connect this pin to one of the crystal oscillator's pins.
10	XTAL	Crystal Oscillator	To deliver an external clock pulse to the chip, this pin should be linked to the other pin of the crystal oscillator.
11	PD5	Digital Pin (PWM)	External counter source Timer 1 is connected to pin 11.
12	PD6	Digital Pin (PWM)	i/ps Positive Analog Comparator
13	PD7	Digital Pin	i/ps Analog Negative Comparator
14	PB0	Digital Pin	Source pin for a counter or timer
15	PB1	Digital Pin (PWM)	Compare A with a counter or timer.
16	PB2	Digital Pin (PWM)	This pin serves as a slave i/p.
17	PB3	Digital Pin (PWM)	The SPI interface includes this pin as a masters output data and slave data input.
18	PB4	Digital Pin	This pin serves both as a master and slave clock input and output.
19	PB5	Digital Pin	For SPI, this pin serves as both a master clock output and a slave clock input.
20	AVcc	Positive Voltage	ADC's positive voltage.
21	AREF	Analog Reference	Analog Reference voltage for ADC (Analog to Digital Converter)
22	GND	Ground	Ground
23	PC0	Analog Input	Analog input digital value (channel 0)
24	PC1	Analog Input	Analog input digital value (channel 1)
25	PC2	Analog Input	Analog input digital value (channel 2)
26	PC3	Analog Input	Analog input digital value (channel 3)
27	PC4	Analog Input	Analog input digital value (channel 4). This pin can also be used as a serial interface connection for data.
28	PC5	Analog Input	Analog input digital value (channel 5). This pin is also used as a serial interface clock line.

**VI. FRAME WORK OF CARBON EMISSIONS MONITOR DEVICE**

- 1) *Sensor Layer:* A dispersed sensor community which include RFID sensors, a GPS module, an acceleration sensor, and an air stress sensor collects actual-time emissions statistics. RFID generation is used to discover the "ID" of additives within side the production process. The outcomes have been used to calculate embodied emissions. If a creation module is diagnosed as "Component A," for example, its ID is study and despatched to a far off computer. To whole the EE measurement, the size and cloth intake statistics of Component A could be routinely accrued from a prefabricated thing statistics database.
- 2) *Laser Detectors:* Each station of the additives manufacturing line has pairs of laser sensors placed on the access and exit, respectively. These sensors are used to decide the region of a thing within side the manufacturing line in actual time in addition to the manufacture time (T) in every station, which is likewise the equipment's operation time.
- 3) *GPS Module:* The GPS module is used in the course of thing transport in addition to on-web website online cloth transfer. 1) Phase of thing transportation. Because the diver's cellphone has a GPS module, the transit path and distance may be calculated the usage of a web map, along with Google Maps. 2) Work on cloth transfer. A GPS module is hooked up on a truck that transports substances on the development web website online to music its distance travelled.
- 4) *Accelerate Sensors:* An accelerometer is hooked up at the tower crane hook to reveal vertical and horizontal acceleration. The acceleration sensor can hence discover whether or not the tower crane is functioning or not, in addition to how lengthy it is been running. Sensors for air stress. An air stress detector, that could calculate the peak of the elevator through sensing air stress variations, is located to reveal the running ability and operation time (T) of the development elevator.
- 5) *Virtual Version:* The digital version illustrates creation sports and emissions calculation outcomes. Emerging BIM software program gives a large array of alternative for creation sports. Mobile device: Digital phone, along with mobileular devices, permit challenge groups to report carbon emissions in actual time shape everywhere at any time. Smart telephones should use cloud statistics offerings to replace emission outcomes in a well timed way and visually show creation sports which are synchronised with the digital version. Furthermore, emissions manipulate commands and caution alarms may be brought to the workers clever phone, capable of take suitable corrective moves to lessen carbon emissions.
- 6) *System Implementation:* This generation became first used to assess its effectiveness and applicability in a element production scenario. Embodied and direct emissions may be tracked in actual time and sort of warning signs in a digital version which additionally acts as a generation platform of RFID and laser induction devices.[47]

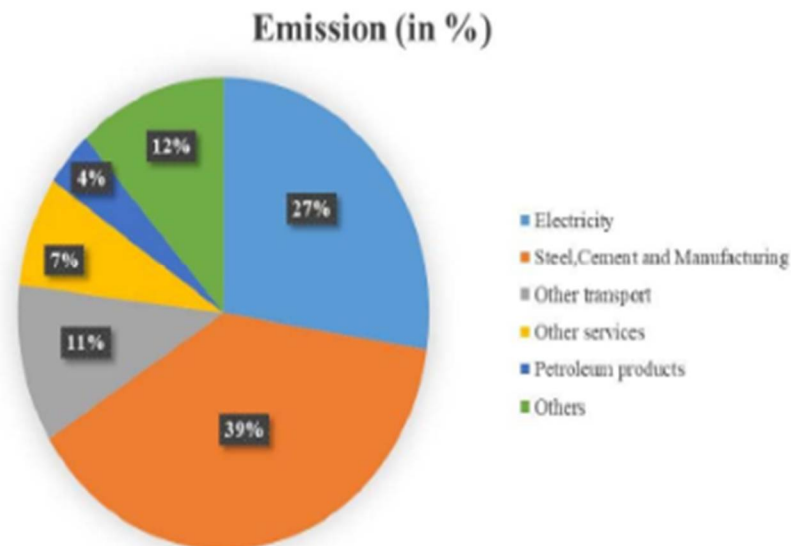

Fig 10: CO2 Emissions by Sectors[48]

It is a big quantity contributing 1.14 heaps in step with capita. These emissions are primarily based totally on modern-day to be had Social Accounting Matrix (SAM). Different varieties of street styles majorly have an effect on CO2 emissions due to abnormal and sloppy roads. The impact of street grade has been evaluated on gas intake which compares the gas economy.

Year	Norms	CO (g/km)			HC+ NOx (g/km)		PM (g/kwhr)	Diesel Vehicles	
		Passenger cars	Diesel vehicles	2/3 wheeler	Passenger cars	2/3 wheeler	Diesel vehicles	HC (g/kmhr)	NOx (g/kmhr)
1991	-	14.3 - 27.1	14	12 - 30	2.0 (Only HC)	8-12 (only HC)	-	3.5	18
1996		8.68 - 12.40	11.2	4.5	3.00-4.36	3.6	-	2.4	14.4
1998		4.34 - 6.20	-	-	1.50-2.18	-	-	-	-
2000	India stage - 2000 norms	2.72	4.5	2.0	0.97	2.0	0.36	1.1	8.0
2008	BS - II	2.2	4.0	1.6	0.5	1.5	0.15	1.1	7.0
2010	BS - III	2.3	2.1	1.0	0.35	1.0	0.10	1.6	5.0
	BS - IV	1.0	1.5	-	0.18	-	0.02	0.96	3.5

From this circumstance it is able to be visible that, gasoline intake on flat course is averagely 15% to 20% better than that of hilly routes. Meanwhile, gasoline intake and emissions are in comparison the use of exclusive using styles like surprising acceleration, surprising breaking and walking the automobile in idle circumstance that have a robust effect in emission. It has been envisioned that gasoline may be stored as much as 19% for guide motors and 7% for an automated ones. [48]

### A. GSM Module

As proven in Figure 11, a custom Printed Circuit board is designed to create a unmarried board that consists of all of the vital layout blocks. The variable voltage circuit ensures that the majority of the additives at the board obtain voltage as in accordance their specifications. The Atmega328P microcontroller regulates and synchronises the module's operation; it additionally controls the GSM module's operation and handles instructions and facts from outside device.

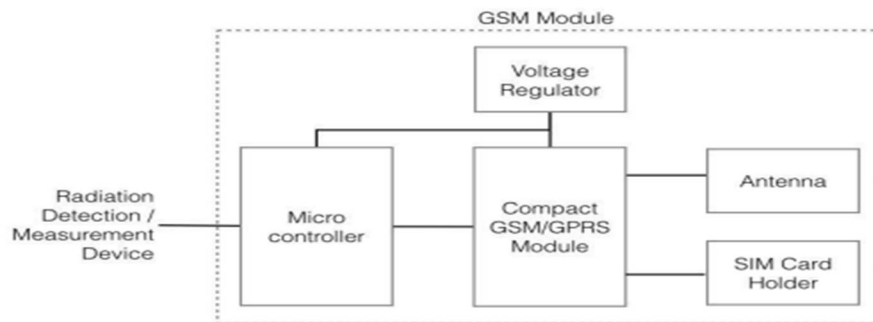

Fig 11. Block diagram of GSM PCB module[49]

The PCB become advanced consistent with Telit's guidelines. The GSM Module's voltage regulator is three.eight volts, whilst a Atmega328P microcontroller's voltage regulator is three.three volts. Figure eleven depicts the completed PCB. The PCB's small length allows it to be without problems included right into a survey meter/region reveal enclosure or a small compact casing for outside connection. GSM stands for worldwide device for cell and is a cell communique modem (GSM). In 1970, Bell Laboratories got here up with an concept for GSM. It is likewise the world's maximum broadly used cell communique device.[49]

There are diverse mobileular sizes in a GSM device together with macro, micro, pico, and umbrella cells. Each mobileular varies as in line with the growing domain. There are 5 extraordinary mobileular sizes in a GSM community macro, micro, pico, and umbrella cells. The quantity of safety it offers for that region of every mobileular varies consistent with the implementation environment.



Fig 12: GSM Modem [50]

A GSM devoted connection that may be any other cellphone or a modem that lets in computer systems or different tool to speak throughout a community. A Modem desires a Local sim to function and operates on a community variety which the community operator had additionally subscribed to. It may be used to connect with a pc through ethernet, USB, or Bluetooth. [50]

Features of GSM Module

The GSM module contains the subsequent features.

- 1) Spectrum abilities have developed.
- 2) Roaming globally
- 3) Compatibility with the virtual community of incorporated offerings (ISDN)
- 4) Support for the brand new offerings is available.
- 5) Management of SIM time period can refer
- 6) Fixed telecellsmartphone number (FDN)
- 7) Alarm clock that works in actual time.
- 8) Great communication
- 9) Securely encrypted telecall smartphone calls to make sure secure.

## VII. CONCLUSIONS

IOT is not only connected with the vast technology but it is more interconnected to the widespread community framework. The agenda of the smart city will be the temperature, it will automatically measure the temperature according to the environment in the smart home. In the smart garden according to the water level monitor, water will be come out by the lawn sprinkler. The aim of this research paper is to develop a modern city through which the life of the people becomes easy. This paper focused on smart home, smart parking system, smart grid and smart garden. To recognize the principle of organization, some of the constituents of smart city are express in detail. In the future, some of the provocation and possibilities supply direction for the research work.

## REFERENCES

- [1] HE Kebin, ZHANG Qiang and HUO Hong "TYPES AND AMOUNTS OF VEHICULAR EMISSIONS", Website: <http://www.eolss.net/Eolss-sampleAllChapter.aspx>, 2015.
- [2] Bo Peng, Xiaoying Tong, Shijiang, Wenying and Gui Xu "Carbon Emission Calculation Method and Low-Carbon Technology for Use in Expressway Construction", April 2020, DOI: [10.3390/su12083219](https://doi.org/10.3390/su12083219).
- [3] C Iclodean "Comparison of Different Battery Types for Electric Vehicles", C Iclodean et al 2017, IOP Conf. Ser. Mater. Sci. Eng. 252 012058.
- [4] Chi T.P. Nguyen, Bào-Huy Nguyễn, João Pedro and F. Trovão "Effect of battery voltage variation on electric vehicle performance driven by induction machine with optimal flux-weakening strategy", *Volume 10, Issue 4*, December 2020, pp. 351 – 359, DOI: [10.1049/iet-est.2020.0013](https://doi.org/10.1049/iet-est.2020.0013).
- [5] Vishal Anand, Varsha Singh and Vinay Kumar Ladwal "Study on PCB Designing Problems and their Solutions". 2019 International Conference on Power Electronics, Control and Automation (ICPECA), 2019, pp. 1-5, doi: 10.1109/ICPECA47973.2019.8975402.
- [6] Tan Yan and Martin D. F. Wong "Recent Research Development in PCB Layout". 2010 IEEE/ACM International Conference on Computer-Aided Design (ICCAD), pp. 66-69 DOI: [10.1109/ICCAD.2010.5654190](https://doi.org/10.1109/ICCAD.2010.5654190)
- [7] Kinnera Bharath Kumar Sai\*, Somula Ramasubbareddy, And Ashish Kr. Luhach "Iot Based Air Quality Monitoring System Using Mq135 And Mq7 With Machine Learning Analysis", December 2019 *Scalable Computing* 20(4):599-606, DOI: [10.12694/scpe.v20i4.1561](https://doi.org/10.12694/scpe.v20i4.1561).
- [8] Arash Sepehri "Inventory Management Under Carbon Emission Policies: A Systematic Literature Review", *Decision Making in Inventory Management* 2012.
- [9] Kayode S. John and Kamson Feyisayo "Air Pollution by Carbon Monoxide (CO) Poisonous Gas", August 2013, *Atmospheric and Climate Sciences* 3(04):510, DOI: [10.4236/acs.2013.34053](https://doi.org/10.4236/acs.2013.34053)
- [10] V.Ramyaa, B. Palaniappan, K.Karthick, Subash Prasad, "Embedded System for Vehicle Cabin Toxic Gas Detection and Alerting". DOI: [10.1016/j.proeng.2012.01.939](https://doi.org/10.1016/j.proeng.2012.01.939), 2012.
- [11] Akshay Singh, Sakshi Sharma, Shashwat Singh, "Android Application Development using Android Studio and PHP Framework", *International Journal of Computer Applications* (0975 – 8887) Recent Trends in Future Prospective in Engineering & Management Technology 2016.
- [12] R. Asritha, R. Arpitha, "A Survey Paper on Introduction to Android and Development Process", Volume:03/Issue:12/December-2021, e-ISSN: 2582-5208.
- [13] Neha Verma, Sarita Kansal, Huned Malvi, "Development of Native Mobile Application Using Android Studio for Cabs and Some Glimpse of Cross Platform Apps", *A Monthly Journal of Computer Science and Information Technology, JCSMC*, ISSN 2320-088X Vol. 6, Issue. 9, September 2017, pp.16-20.
- [14] R. Al-Ali, Imran Zualkernan, and Fadi Aloul, "A Mobile GPRS-Sensors Array for Air Pollution Monitoring", November 2010, *IEEE Sensors Journal* 10(10):1666 - 1671, DOI: [10.1109/JSEN.2010.2045890](https://doi.org/10.1109/JSEN.2010.2045890)
- [15] Felix Uribe, "The classification of Internet of Things (IoT) devices Based on their impact on Living Things", June 2017, *SSRN Electronic Journal*, DOI: [10.2139/ssrn.3350094](https://doi.org/10.2139/ssrn.3350094).
- [16] Pejman Panahi, Cuneyt Bayolumu, "Car Indoor Gas Detection System", Volume 9, No.1.5, 2020, website: <https://doi.org/10.30534/ijatcse/2020/4791.52020>.
- [17] A. Ismail, M.F. Ariffin and S.A. Noor, "Study Of Electric Vehicle Battery Reliability Improvement", *International Journal of Reliability and Applications*, Vol. 12, No. 2, pp. 123-129, 2011.
- [18] Waleed M. Sweileh, Samah W. Al-Jabi, Sa'ed H. Zyoud, Ansam F. Sawalha, "Outdoor air pollution and respiratory health", DOI: [10.1186/s40248-018-0128-5](https://doi.org/10.1186/s40248-018-0128-5),

2018.

- [19] Karan C. Prajapati 1,\* , Ravi Patel 2 and Rachit Sagar 3, "Hybrid Vehicle: A Study on Technology", Volume 3, Issue 12, December 2014.
- [20] Frances C. Moore, "Climate Change and Air Pollution: Exploring the Synergies and Potential for Mitigation in Industrializing Countries", Yale School of Forestry and Environmental Studies, 195 Prospect St, New Haven, CT 06511, USA, Sustainability 2019, 1(1), 43-54; <https://doi.org/10.3390/su1010043>.
- [21] J.G.J. Olivier and J.A.H.W. Peters "Trends In Global Co2 And Total Greenhouse Gas Emissions", 2017.
- [22] Shanshan Li1, Yam Wing Siu2 and Guoqin Zhao "Driving Factors of CO2 Emissions: Further Study Based on Machine Learning", website: <https://doi.org/10.3389/fenvs.2021.721517>, 2021.
- [23] Jijun Kang and Yanjun Yang "Energy carbon emission structure and reduction potential focused on the supply-side and demand-side", website: <https://doi.org/10.1371/journal.pone.0239634>, October 6, 2020.
- [24] Tao Gao, Qing Liu and Jianping Wang "A comparative study of carbon footprint and assessment standards", International Journal of Low-Carbon Technologies, Volume 9, Issue 3, September 2014, pp.237-243.
- [25] "Global Research on Carbon Emissions: A Scientometric Review" by Lebunu Hewage Udara Willhelm Abeydeera, Jayantha Wadu Mesthrige and Tharushi Imalka. Samarasinghalage, 2019, vol. 11, issue 14, pp. 1-25.
- [26] Marco Miotti, Geoffrey J. Supran, Ella J. Kim and Jessika E. Trancik "Personal Vehicles Evaluated against Climate Change Mitigation Targets", 2012.
- [27] Luke Van Der Male "Literature Review of Emissions Control", International Journal of Advanced Trends in Computer Science and Engineering, 2020.
- [28] M F Ibrahim, M M Putri and D M Utama "A literature review on reducing carbon emigration", Proceedings - 2012 8th International Conference on the Quality of Information and Communications Technology", 2012, pp .255-260. doi:10.1109/QUATIC.2012.56.
- [29] Pattar Sunil Mahesh, Patil Bhushan Rajendra, Bodke Akshay Dnyaneshwar, Mr. Ulhās, V. Patil "A PAPER ON AIR POLLUTION MONITORING USING IOT", 2014.
- [30] Krishna and M. Nagarajapandian, "IoT Based Vehicle Emission Monitoring and Alerting", IEEE Student Conference on Research and Development (SCORED), 2019, pp.161-165, doi: 10.1109/SCORED.2019.8896289.
- [31] Mahesh Kavre and Yash Gadhade "Internet of Effects (IoT)", 2014.
- [32] ShirsenduSikdar DianziLiU AbhishekKundu "Acoustic emission data based deep learning approach for classification and detection of damage-sources in a composite panel", Composites Part B: Engineering, vol 228, doi: 10.1016/j.compositesb.2021.109450
- [33] Kuranc A "Exhaust emission test performance with the use of the signal from air flow meter", 2018.
- [34] Chairul Saleh, Nur Rachman Dzakiyullah, Jonathan Bayu Nugroho "Carbon dioxide emission prediction using support vector machine", IOP Conference Series: Materials Science and Engineering, 2016, doi:10.1088/1757-899x/114/1/012148
- [35] Mort Dittenhofer, "Environmental accounting and auditing", Managerial Auditing Journal, Vol. 10 No. 8, 1995, pp. 40-51.
- [36] Ribeiro, André & Silva, Alberto. (2012). "Survey on Cross-Platforms and Languages for Mobile Apps", Proceedings - 2012 8th International Conference on the Quality of Information and Communications Technology", 2012, pp .255-260. doi:10.1109/QUATIC.2012.56.
- [37] Pohares, V. C. Kulloli, T. Bhattacharyya, and S. Bhure, "Cross Platform Mobile Application Development", 2014.
- [38] Tsvetan Tsokov; and Dessislava Petrova-Antonova "EcoLogic: IoT Platform for Control of Carbon Emissions", In Proceedings of the 12th International Conference on Software Technologies (ICSOFTE 2017), pp. 178-185, doi: 10.5220/0006462201780185.
- [39] Ms, Sruthi & Newlin Rajkumar, Manokaran. (2017) "IoT Based Smart System for Controlling Co 2 Emission", 10.13140/RG.2.2.26703.33444.
- [40] Gomes, João B.A., Joel J.P.C. Rodrigues, Ricardo A.L. Rabêlo, Neeraj Kumar, and Sergey Kozlov. 2019. "IoT-Enabled Gas Sensors: Technologies, Applications, and Opportunities &quot;, Journal of Sensor and Actuator Networks 8, no. 4: 57. doi:
- [41] Goh Siew YEN, Kohbalan Moorthy, Logenthiran Machap "IOT based Vehicle Carbon Monoxide Monitorig, Alerting and Controlling System", International Journal of Advanced Trends in Computer Science and Engineering, 2020, vol. 9, doi:10.30534/ijatcse/2020/4791.52020.
- [42] I. Priyanka , R. Sandeep , V. Ravi, O. Shekar, "Battery Manganement System in Electric Vehicles", 2019.
- [43] Kawamoto, R. Mochizuki, H. Moriguchi, Y. Nakano, T. Motohashi, M. Sakai, Y. Inaba, "Estimation of CO 2 Emissions of Internal Combustion Engine Vehicle and Battery Electric Vehicle Using LCA". Sustainability 2019, vol. 11, pp.45-67. doi: 10.3390/su11092690
- [44] Xing, Yinjiao, Eden W. M. Ma, Kwok L. Tsui, and Michael Pecht "Battery Management Systems in Electric and Hybrid Vehicles"; Energies 4, pp. 11, doi:10.3390/en4111840.
- [45] A. R. Al-Ali, I. Zualkernan and F. Aloul, "A Mobile GPRS-Sensors Array for Air Pollution Monitoring," in IEEE Sensors Journal, 2010, vol. 10, pp. 1666-1671, doi: 10.1109/JSEN.2010.2045890.
- [46] Shivkumar Bagde, "8-bit AVR Microcontrollers Atmega328/P", 2016.
- [47] Mao, Chao & Tao, Xingyu & Yang, Hao & Chen, Rundong & Liu, Guiwen. "Real-Time Carbon Emissions Monitoring Tool for Prefabricated Construction: An IoT-Based System Framework", 2018, pp. 121-127, doi:10.1061/9780784481738.015.
- [48] P. A. M. Devan, F. A. Hussin, R. Ibrahim, K. Bingi and M. Nagarajapandian, "IoT Based Vehicle Emission Monitoring and Alerting System," 2019 IEEE Student Conference on Research and Development (SCORED), 2019, pp. 161-165, doi: 10.1109/SCORED.2019.8896289.
- [49] Nur Aira Abd Rahman, Noor Hisyam Ibrahim, Lojius Lombigit, Azraf Azman, Zainudin Jaafar, Nor Arymaswati Abdullah, and Glam Hadzir Patai Mohamad, "GSM module for wireless radiation monitoring system via SMS", IOP Conf. Series: Materials Science and Engineering 298, 2018, pp. 2-3, doi:10.1088/1757-899X/298/1/012040.
- [50] Ma Yuchun, Huang Yinghong, Zhang Kun, Li Zhuang, "General Application Research on GSM Module," 2011 International Conference on Internet Computing and Information Services, pp. 3-4, doi: 10.1109/ICICIS.2011.137.



10.22214/IJRASET



45.98



IMPACT FACTOR:  
7.129



IMPACT FACTOR:  
7.429



# INTERNATIONAL JOURNAL FOR RESEARCH

IN APPLIED SCIENCE & ENGINEERING TECHNOLOGY

Call : 08813907089  (24\*7 Support on Whatsapp)